

# SE Encore Speed Reducers

## SE Encore Worm Gear Disassembly and Reassembly Instructions

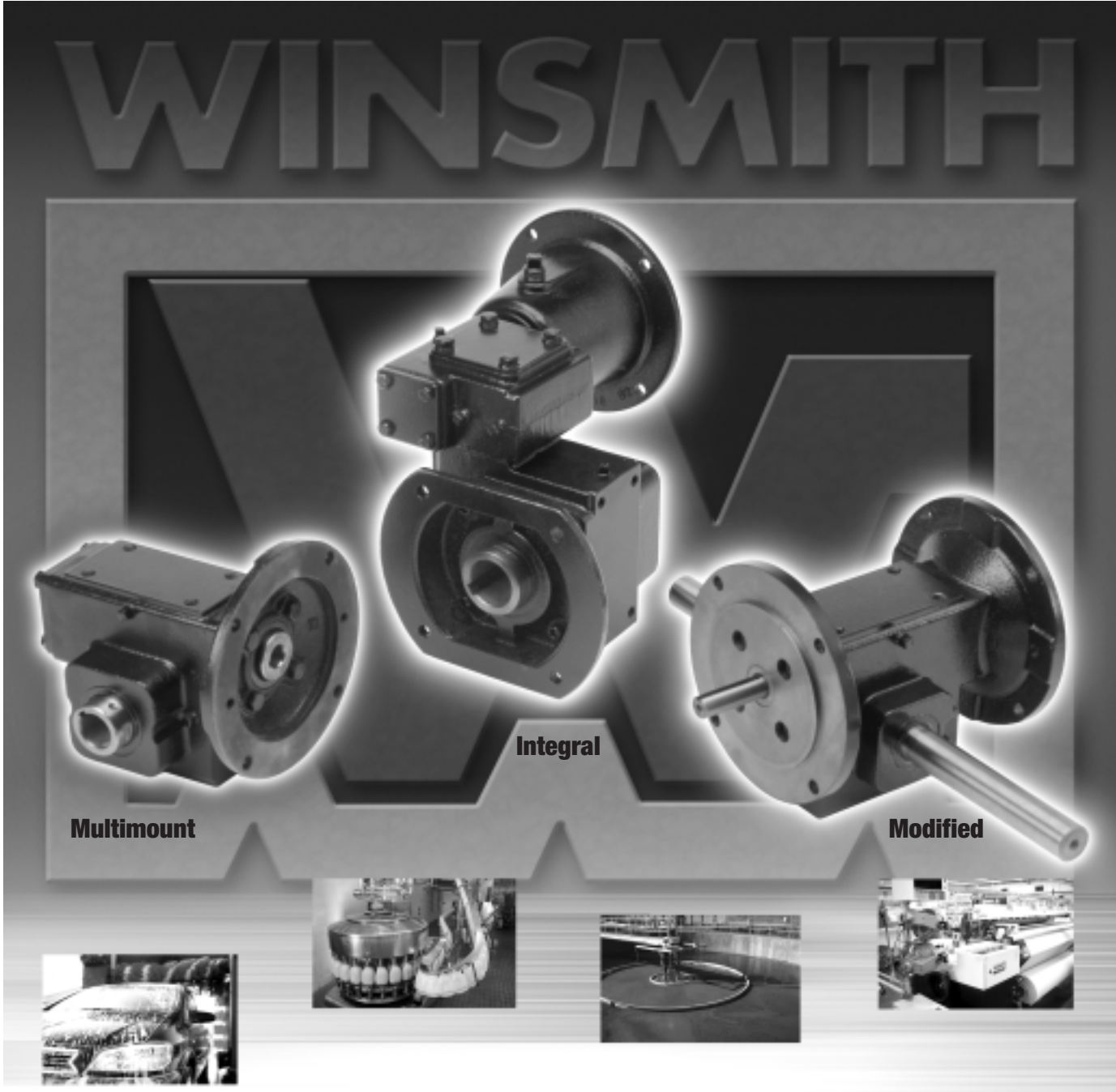

# SE Encore Speed Reducers

The following describes the procedures for disassembling and reassembling SE Encore speed reducers. These instructions can also be used for specific tasks such as changing assemblies or gearing (ratio) by referring to the appropriate sections. However, it is recommended that all instructions be reviewed before proceeding. They are combined to cover all reducers and, in those situations where models differ, will differentiate between specific models. Although the sequence may be determined by the task, it will be necessary to remove the output shaft and gear assembly before removing the input (worm) shaft. If seals are going to be reused, such as with new reducers, they must be protected by covering the shaft keyways with smooth tape before disassembly. **Figure 1** illustrates the location of the various parts (1- 32) referenced throughout the text.

## Prior to Disassembly

1. Remove motor and coupling (if applicable).
2. Remove keys and set screws (hollow shaft models). Check shafts for damage and remove any protruding nicks that may impede seal or bearing removal.
3. Clean the outside of the housing. Remove foreign material that may contaminate any components or lubricant being reused.
4. Drain the oil. The plugs adjacent to the worm should be avoided as the internal vent shield will impede oil flow. Drain both housings in double reduction models.

## Disassembly

5. Disassemble the output cover(s) (16) or cover and base (DV model) from the housing. Disassemble both covers (16 & 22) on hollow shaft models (DSF or DSR). With DL models, first disassemble the output bearing cap (32) and then disassemble the cover and base (31) from the housing.
6. Remove the output shaft and gear assembly from the housing. With single cover designs, tilt the output gear away from the input worm shaft. It may be necessary to apply a small amount of pressure to the shaft extension, using the inner bearing as a pivot point, to separate the

gear from the worm. When disassembling reducers with double output shaft extensions, it may be necessary to remove the seal opposite the output cover prior to removing the output gear assembly from the housing.

Steps 7 through 11 apply to the primary stage of double reduction models. If single reduction, proceed to step 12.

7. Remove attachment housing cover (28).
8. Remove fastener and washer (26 & 27) at end of exposed shaft.
9. If the primary gear (24) is being reused, mark the outer face for reference so the gear may be reinstalled in the same position (reference face out). Remove gear (24) and spacer (29) (if applicable) from shaft. This will be a sliding fit. If the gear does not easily disengage from the worm, remove the intermediate cap (2) and slide the intermediate worm (6) out the rear side of the main housing until the shaft extension clears the primary gear. On E35 and E43 models, it will only be necessary to loosen the intermediate cap, allowing the primary gear to tip away from the worm due to the tapered intermediate bearings.
10. Disassemble the motor adaptor (8) (if applicable). Disassemble the input cap (2) from the attachment housing (25). Remove the primary worm by tapping it toward the input cap end. With single bearing designs (hollow input), the worm (9) may be completely removed at this time. With two bearing designs (solid input), the snap ring (4) must be removed before sliding the worm (6) and front bearing (5) through this bore.
11. Disassemble the attachment housing (25) by removing the four fasteners (30) located behind the primary gear (24). The housing will also be supported by two dowel pins partially engaged in the main housing.

If this is a double reduction reducer, steps 12-15 relate to the main housing components.

12. Disassemble the motor adaptor (8) (if applicable). Disassemble the input bearing cap(s) (2, 11 & 12 or 14). With two bearing designs in sizes E13-E30, (solid input), the snap ring (4) must be removed before sliding the worm (6) and front bearing (5) through this bore.



# SE Encore Speed Reducers

13. If seals are to be replaced, remove the worn seals from the housing and covers. If two seals are used at a particular location, it is important that both be replaced exactly as removed (i.e. tandem or opposed). Tandem seals provide extra protection against leakage while opposed seals assist in preventing outside contaminants from working their way into the reducer.
14. If bearings are to be replaced, remove them from their respective shafts using a press. Note the position of these bearings on the shafts, so the reducer can be rebuilt accordingly. Care must be taken not to damage the seal areas of either shaft. Remove the bearing races from the housing and cover using a soft metal drift. When driving them out, exercise caution not to damage the housing or cover bearing seat. The compression ring (18) behind the bearing cup in the cover will be reused in this location as a spacer.
15. Thoroughly clean all parts in preparation for reassembly. Remove all gasket material and sealant from mating surfaces. Inspect all parts for damage or wear and replace as necessary.

CAUTION: If a shaft seal area is cleaned with emery paper, the direction of the resulting finishing marks in the shaft must be perpendicular to the shaft axis. Any small lead inscribed in the shaft surface while cleaning, may create a path for oil seepage.

## Reassembly—Single Reduction Models

16. Reassemble the input shaft bearings. Press the new input ball bearings (3 & 5) or tapered roller bearing cones (10) on the worm shaft until tight against the backing shoulders. To prevent damage to the bearing, press against the inner race only. Secure the rear bearing(s) with snap rings (1) or locknut (13) as dictated by the worm design.
17. Reassemble the output shaft and bearing assembly. Press the output gear (20) and key on the shaft (17 or 21) to its original position making sure the key is not extending beyond the gear hub. Add spacers (if applicable) and

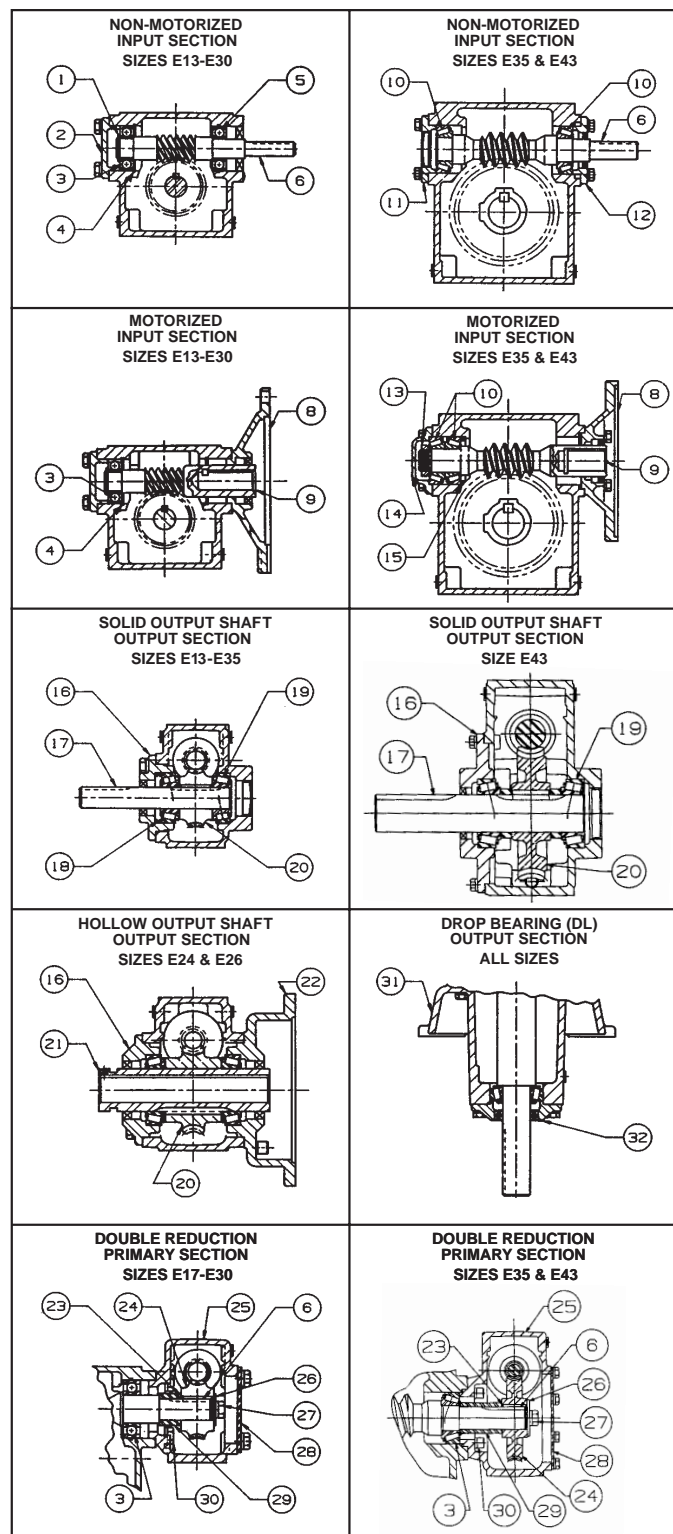

FIGURE 1

# SE Encore Speed Reducers

press the bearing cones (19) tight against the adjacent spacer or gear hub. Press against the inner cone race only, avoiding contact with the roller cage. When pressing the bearings or gear, be extremely careful not to damage the shaft seal surface.

**18.** Install the output shaft bearing races.

- a. For single cover models (see item 18d for DL models), install one race in the housing making sure it is properly seated. This should be a tight fit. Insert the compression ring (18) into the bearing seat of the output cover (16) or DV cover and base followed by the bearing race. This should be a sliding fit.
- b. For E24 and E26 hollow shaft models, install bearing races in each of the output covers (16) or cover and base (22) making sure they are properly seated. Each should be a tight fit.
- c. Other hollow shaft models have a single output cover. Install bearing race in housing and cover; making sure they are properly seated. Both are press fit.
- d. For DL models, install one bearing race in the housing, making sure it is properly seated. This should be a tight fit.

**19.** Assemble the input shaft (6) in the housing. For Sizes E35 and E43, see items 19b and 19c below.

- a. Sizes E13 through E30. For models using two input ball bearings, insert the input shaft assembly into the rear (input cap) side of the housing and slide through until the front bearing (5) clears the rear snap ring groove. Install the snap ring (4) in the rear housing groove, making sure it is completely seated. Continue inserting the worm in the housing until the rear bearing shoulders against the snap ring. For single bearing assemblies, the snap ring (4) may be installed first. Attach the input cap (2) using the required thickness of gaskets that will take up the clearance between the cap and housing while trapping the bearing between the cap and snap ring. This will prevent the bearing from moving axially during load reversals. Proceed to step 20.

- b. Sizes E35 and E43 with solid input shaft. Slide the front input bearing race into the housing for the proper assembly. Using one gasket (.010"), assemble the front input cap (12) or coupling style motor adaptor. Insert the worm (6) from the opposite end of the housing and install second bearing race. Attach rear input cap (11) using the required thickness of gasket to provide .002-.004 inch endplay. Tap each end of the worm with a nonmetallic hammer to seat the bearings before checking endplay. Proceed to step 20.
- c. Sizes E35 and E43 with hollow input shaft (motorized). Insert input spacer (15) and inner bearing race (10) into rear input side of housing. Insert worm (9) from the rear housing side until it rests against the inner bearing race. Install the outer race. Attach rear input cap (14) using the required thickness of gasket to provide .002-.004 inch endplay. Tap the end of the worm and the rear input cap with a non-metallic hammer to seat the bearings before checking endplay.

**20.** Assemble the output shaft assembly in the housing.

When attaching covers, apply a small amount of liquid sealant to the thread area of all fasteners to prevent leakage in this area. See instruction 20b for Size E43 and hollow shaft models.

- a. With the output shaft (17) extension positioned for the proper assembly, rest the inside bearing cone in its mating cup (race) in the housing. Snap the gear into mesh by applying a small amount of pressure against the end of the output shaft. At this point, the gear is automatically centered over the worm by means of component dimensional tolerances. If the reducer is a DL Series, refer now to 20c. Attach the output cover (16) (DV cover and base) using the proper thickness of gaskets that will provide up to .002 inches end-play while avoiding any bearing preload. Tap the end(s) of the shaft or opposite cover with a non-metallic hammer before checking endplay. If this cannot be achieved with at least one gasket, add about .010 inch shim stock in the

# SE Encore Speed Reducers

output cover bearing bore behind the compression ring (18) and reassemble per the above instructions. Proceed to step 21.

- b. Assemble one output cover (16) or cover and flange (22) without gaskets and insert the shaft and gear assembly. It may be helpful to position the gear in mesh with the worm before securing the first cover. Assemble the opposite cover using the proper thickness of gaskets that will provide up to .002 inch endplay while avoiding any bearing preload. Tap each end of the shaft with a non-metallic hammer to seat the bearings before checking endplay. Once this is established, remove both covers, equally distribute the gaskets between the two covers and reassemble. Proceed to step 21.

- c. Attach the output cover and base (31) to the housing using one .010 inch gasket. Insert the outer output bearing race. Attach the output bearing cap (32) using the proper thickness of gaskets that will provide up to .002 inch endplay while avoiding any bearing preload. Tap the end of the shaft and opposite cover with a non-metallic hammer before checking endplay.

21. If motorized, attach the motor adaptor (8) using one .010 inch gasket. If the reducer uses a coupling style motor adaptor, install the input seal in the housing (refer to step 22 for seal mounting instructions).

22. Install all seals using the following instructions. Lubricate the shaft seal areas with a light coat of oil. Apply a thin layer of liquid sealant to the housing or cover bore area that supports the seal. Protect the seal lips by covering all shaft keyways or other sharp corners with smooth tape. Slide seal up to bore, being careful not to displace the seal spring or roll the seal lip over. Tap into place using a blunt surface that will not deform the seal casing. When installed, the seal should be flush with the casting surface and perpendicular to the shaft axis. If two seals are installed, fill the cavity between them with grease. Use the outer seal to drive in the inner seal, leaving it extended about 1/16" from the casting surface.

23. If the ratio, assembly, or any other feature was changed, a new nameplate reflecting these changes should be used. This will insure proper parts or reducer replacement in the future. Contact your local Winsmith sales representative for assistance.

24. Recheck all fasteners. Tighten to the torques listed in the following table.

## HEX HEAD CAP SCREW RECOMMENDED TORQUE VALUES

REDUCER SIZE	ATTACHMENT HOUSING				MAIN HOUSING			
	CAP	MIN/MAX TORQUE (lbs.-in.)	COVER	MIN/MAX TORQUE (lbs.-in.)	CAP	MIN/MAX TORQUE (lbs.-in.)	COVER	MIN/MAX TORQUE (lbs.-in.)
E13	N/A	N/A	N/A	N/A	1/4-20	105/123	5/16-18	216/253
E17-E20	1/4-20	105/123	5/16-18	189/222	5/16-18	216/253	5/16-18	216/253
E24-E26	5/16-18	216/253	5/16-18	189/222	3/8-16	382/449	5/16-18	216/253
E30-E35	5/16-18	216/253	5/16-18	189/222	3/8-16	382/449	3/8-16	382/449
E43	3/8-16	382/449	5/16-18	189/222	3/8-16	382/449	3/8-16	382/449

25. Fill reducer with oil. Refer to page 9 and note the plug locations for the appropriate model and mounting position. Using the fill and level plugs as shown, add oil (see page 7 for recommended oils) until it just begins to flow out the level plug location. For double reduction models, fill each housing individually. Install all plugs while making sure the vent is in its proper location and the vent opening is clear.

## Reassembly—Double Reduction Models

26. Reassemble the main housing components per steps 16 through 19 but do not assemble the output shaft into the housing yet.

27. Reassemble the attachment housing (25) using one .010 inch gasket, two dowel pins and four fasteners. See steps 44 and 45 if the primary housing is being repositioned for a change of assembly.

28. Reassemble the primary stage worm using steps 16 and 19.

29. Slide the spacer (29) on the intermediate shaft (6) extension up to the backing shoulder.

30. Slide the primary gear (24) on the intermediate shaft and seat against the spacer. If the gear does not easily slide into mesh with the worm, proceed as follows:



# SE Encore Speed Reducers

- a. Sizes E17-E30: Remove the intermediate cap (2) and slide the worm (6) out of the main housing. Position the primary gear (24) in mesh with the worm and reintroduce the intermediate worm in the housing with the extension end passing through the gear bore. Reattach the intermediate cap. Secure the gear with a fastener (27) and washer (26).
- b. Sizes E35 and E43: Loosen the intermediate cap (11) enough to tip the intermediate worm allowing the primary gear to position itself in mesh with the primary worm. Retighten the intermediate cap and secure the gear with a fastener (27) and washer (26).

At this point it is necessary to center the primary gear over the worm to insure proper operation. This is accomplished by adding shims (23) between the gear (24) and spacer (29) as required. The initial shim pack can be estimated by measuring the distance between the gear hub face and machined surface of the attachment housing and referring to the following chart. Any distance greater than the reference dimension is made up with shims. Distances less than this (which normally should not occur) can be accommodated by decreasing the spacer width. The correct position can then be verified by blueing the worm and checking the resulting contact on the gear teeth.

## RECOMMENDED SHIM

REDUCER SIZE	REFERENCE DIMENSION	SHIM PART NUMBERS (.002, .005, .010)
E17-E20	.812	815007, 815008, 815009
E24-E35	.585	815507, 815508, 815509
E43	1.312	817005, 817006, 817007

Once properly shimmed, install the gear key and apply Loctite 242 (or equal) to the fastener before final assembly.

- 31. Reassemble the balance of the reducer using steps 20 through 25.

## Assembly Conversions

### I. Reverse the output shaft of a solid output shaft model:

- 32. Refer to steps 2 through 6 and proceed where applicable. Be sure to protect the seal from the keyway before disassembly.

- 33. Remove the output seal and output plug, being careful not to damage either in the process. Coat the housing or cover bore diameter where the seal had been located and reinstall the plug in this location.
- 34. Reassemble the output shaft assembly using the same compression ring, if applicable and the same total thickness of gaskets. Refer to step 20a or b for additional instructions. If either the gear or bearings are changed in the process, it may be necessary to readjust the bearing endplay per the instructions in step 20.
- 35. Complete the reassembly using steps 22 through 25.

### II. Reverse the output shaft of a nonsymmetrical hollow output shaft model:

- 36. Refer to steps 2 through 6 and proceed where applicable. Be sure to protect the seals from the set screw holes and puller groove.
- 37. Reverse the position of the output shaft assembly and reassemble using the same total thickness of gaskets on each cover. Refer to step 20b for additional instructions. If either the gear or bearings are changed in the process, it may be necessary to readjust the bearing endplay per the instructions in step 20.
- 38. Complete the reassembly using steps 22 through 25.

### III. Reverse the assembly of the input shaft (all models):

- 39. It will be necessary to remove the output gear for this conversion. Refer to steps 1 through 6 and step 12 and proceed where applicable. Be sure to protect all seals from keyways or other surface discontinuities before disassembly.
- 40. Reverse the position of the input shaft (6) and snap ring (4) and reassemble using step 19.
- 41. Reassemble the output shaft assembly using step 20.
- 42. Complete the assembly using steps 21 and 23 through 25.

### IV. Rotate the attachment housing:

- 43. Refer to steps 1 through 4 and steps 7 through 11 and proceed where applicable. Be sure to protect the input shaft seal from any keyways before disassembly.



# SE Encore Speed Reducers

44. Remove the two roll pins and reassemble the attachment housing in the desired position, aligning it as square as possible with the main housing. Replace the gasket between the housings if necessary.
45. Using the two roll pin holes as pilots, drill into the main housing about 1/4 inch using a 1/8 diameter drill. Insert the two roll pins.
46. Reassemble the input worm using step 19.
47. Reassemble the input gear using steps 29 and 30 where applicable. If none of the components were changed, the centering operation will not be necessary.
48. Reassemble the balance of the reducer using steps 21 through 25.

## Lubrication

Use Mobil Glygoyle PAG460 Lubricant

**NOTE: SE Encore worm gear speed reducers are factory filled with Mobil Glygoyle 460 (PAG) lubricant. The use of other lubricants may result in substantially lower torque capacity and is not recommended by Winsmith. If other lubricants are used, a thorough flushing procedure is required.**

**NOTE: Helical Gear Ratio Multipliers are factory filled with Mobilgear 600 XP 220 lubricant. The use of other lubricants may result in substantially lower torque capacity and is not recommended by Winsmith. If other lubricants are used, a thorough flushing procedure is required.**

## Initial Start-Up

Prior to start-up, the lubricant level should always be checked. The proper lubricant fill level is dependent on the speed reducer orientation during operation. The appropriate fill, drain, and level plug locations for a variety of models and orientations are shown in **Figures 3 & 4**. Grease fittings, not shown in **Figures 3 & 4**, are used to lubricate bearings when the motor speed is below 1160 rpm. If an alternate mounting position, not shown in **Figures 3 & 4**, is required, please contact your local Winsmith sales representative.

**The oil level should be checked, and adjusted if necessary, prior to operation using the oil level plug provided and while the reducer is oriented in its operating position. Only Mobil Glygoyle 460 or compatible lubricant should be used for reducers containing worm gears.**

During the initial start-up operation, a break-in period is necessary before the reducer reaches maximum operating efficiency. Winsmith recommends a gradual application of load during the first several hours after start-up. The reducer may run hot during this initial break-in period. This is normal. A few drops of oil may weep from the lip seals during the break-in stage. After a short period of operation, clean off any excess oil around the shaft seals and recheck the oil level; adjust if necessary.

## Long Term Storage or Infrequent Operation

If a speed reducer is to stand idle for an extended period of time, either prior to installation or during use, the housing should be completely filled with oil. This will protect the interior components from corrosion due to internal condensation. Be sure to drain the oil to the proper level prior to placing the reducer into service. Contact your local Winsmith sales representative with questions on long term storage.

# SE Encore Speed Reducers

PRODUCT FAMILY	STANDARD MOUNTING	ADDITIONAL MOUNTING POSITIONS			
		INVERTED	INPUT SHAFT HORIZONTAL		INPUT SHAFT VERTICAL
XDNS XDTS XDUS XDHS					
XDBS					
XDJS					
XDVS					
XDLS					
XDSS XSTS XSUS XSHS					
XSBS					
XSJS					
XSFS					
MDDS					
MHDS					

FIGURE 3

1. Fill, vent, level and drain locations are the same for quill and coupled models.
2. Double reduction size E35 and E43 models are supplied with grease fittings on the input shaft to ensure bearing lubrication for all mounting positions.
3. When input speeds are less than 1160 rpm, to ensure proper lubrication, contact your local Winsmith sales representative.

FIGURE 3  
CHART KEY

- (F) REFILL PLUG
- (V) VENT PLUG
- (L) LEVEL PLUG
- (D) DRAIN PLUG

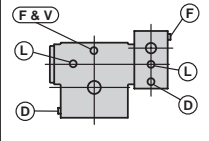
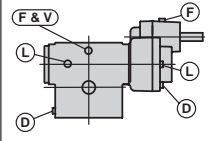
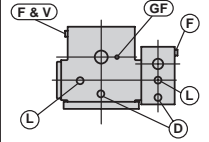
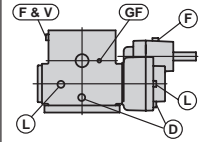
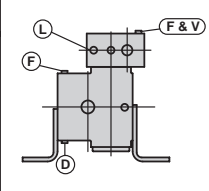
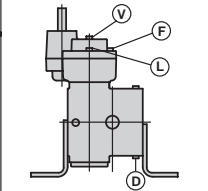
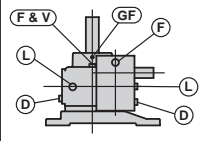
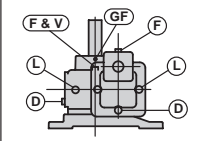
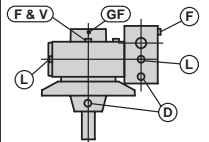
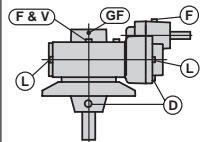
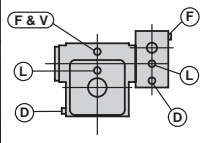
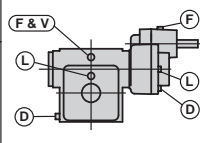
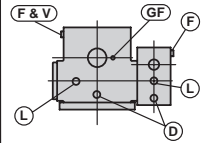
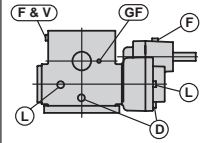
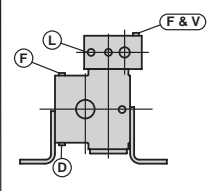
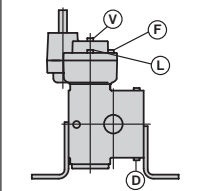
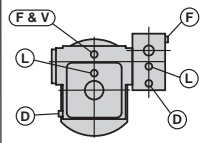
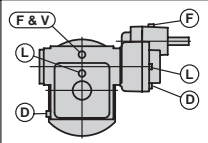

# SE Encore Speed Reducers

DOUBLE REDUCTION WORM/WORM STANDARD MOUNTING		DOUBLE REDUCTION HELICAL/WORM STANDARD MOUNTING	
XDND XDTD XDUD XDHD		XDNX XDTX XDUX XDHX	
XDBD		XDBX	
XDJD		XDJX	
XDVD		XDVX	
XDL D		XDLX	
XDSD XSTD XSUD XSHD		XDSX XSTX XSUX XSHX	
XSBD		XSBX	
XSJD		XSJX	
XSF D		XSFX	

**FIGURE 4**

1. Fill, vent, level and drain locations are the same for quill and coupled models.
2. Double reduction size E35 and E43 models are supplied with grease fittings on the input shaft to ensure bearing lubrication for all mounting positions.
3. When input speeds are less than 1160 rpm, to ensure proper lubrication, contact your local Winsmith sales representative.

**FIGURE 4  
CHART KEY**

- (F) REFILL PLUG
- (V) VENT PLUG
- (L) LEVEL PLUG
- (D) DRAIN PLUG
- (GF) GREASE FITTING

# Warnings And Cautions



## WARNING

### Warnings

Winsmith products, and associated equipment and machinery, are intended for selection and use by trained and skilled persons capable of determining their suitability for the specific application or use. Proper selection, installation, operation and maintenance, including implementation of adequate safety precautions, are the responsibility of the purchaser or user. The following safety precautions, as well as additional safety precautions that may be required for the specific application or use, are the responsibility of the purchaser or user. **FAILURE TO OBSERVE REQUIRED SAFETY PRECAUTIONS COULD RESULT IN SERIOUS INJURY TO PERSONS OR PROPERTY OR OTHER LOSS.**

### Lock-out/Tag-out

It is **EXTREMELY IMPORTANT** that equipment or machinery does not unexpectedly start. To prevent this possibility, all electrical or other input power sources must be turned off, and properly locked out. Tag out procedures must be followed before working on or near the reducer or any associated equipment. Loads on the input and output shafts should be disconnected prior to working on any reducer. Failure to observe these precautions may result in serious bodily injury and/or property damage.

### Grounding

Be sure the reducer and associated equipment are properly grounded and otherwise installed in accordance with all electrical code requirements.

### Protective Guarding / Loose Clothing, etc.

Always insure there is proper protective guarding over all rotating or moving parts. Never allow loose clothing, hair, jewelry and the like to be worn in the vicinity of rotating or moving parts or machinery. The purchaser or user is responsible for complying with all applicable safety codes. Failure to do so may result in serious bodily injury and/or damage to property or other loss.

### Selection & Installation

This speed reducer and associated equipment must be selected, installed, adjusted and maintained by qualified personnel who are knowledgeable regarding all equipment in the system and the potential hazards involved.

### Consult Catalog Ratings

Load, torque and other requirements must not exceed the published ratings in the current catalog and/or on the speed reducer nameplate. The reducer selected must be consistent with all service factors for the application. See Winsmith catalogs and [www.WINSMITH.com](http://www.WINSMITH.com).

### Brake Torque Loads

Whenever a brake or any other stopping force is involved in an application, braking torque loads imposed on the speed reducer must not exceed the allowable load ratings.

### Not a Brake

Speed reducers should never be used to provide the function of a fail safe brake or an assured self locking device. Speed reducers must never be used to replace a brake or a critical braking application function.

### Excess Overhung Loads

Excessive overhung loads on the input or output shafts of a speed reducer may cause premature fatigue failures of the bearings and/or shafts. Mount gears, pulleys and sprockets as close to the housing as possible to minimize such loads. Do not exceed catalog ratings.

### Excess Thrust Loads

Excessive thrust loads on the input or output shafts of a gear reducer may cause premature failure of bearings. Do not exceed catalog ratings.

### Alignment

Properly align any input and output power transfer elements connected to the speed reducer. Even slight misalignments in a rigid mounting system may cause binding, large vibration forces or excessive overhung loads, leading to premature bearing, shaft, or speed reducer failure. Use of flexible couplings that allow the reducer and connected transfer elements to self-align during operation will compensate for minor misalignments.

### Not a Support Structure

A speed reducer must never be used as an integral component of a machine superstructure or support frame that would subject it to additional loads other than properly rated loads transmitted through the shafts.

### Mounting Position

The speed reducer should be mounted in one of the mounting positions shown in the catalog. Different mounting positions should not be used without contacting Winsmith as this may result in improper lubrication.

### Overhead Mounting

Mounting of a speed reducer in overhead positions may be hazardous. Use of external support rails or structure is strongly recommended for any overhead mounting.

### Lifting Eyebolts

Any lifting supports or eyebolts provided on the speed reducer are supplied with the purpose of vertically lifting only the speed reducer, without any other attachments or motors. Inspect such supports and bolts before each use.

### Properly Secure Mounting Bolts

Proper mounting bolts and proper torques must be applied and maintained to insure the speed reducer is securely mounted to the desired machinery. Inspect regularly as machine vibration may loosen fasteners.

### Thread Locking Compound

Proper thread locking compound should be appropriately applied to the cleaned threads of all mounting bolts connecting or securing the speed reducer to equipment and any drive, accessories, or brake components attached to the speed reducer. If, at any time after installation a factory supplied assembly or construction bolt is removed, care must be taken to thoroughly clean off the old thread locking compound and a new appropriate thread locking compound must be applied. Failure to properly apply new thread locking compound on all mounting or reducer construction bolts may result in serious injury or death from falling mechanical components.

### Reducer Surface Is Hot

Operating speed reducers generate heat. Surface temperatures may become hot enough to cause severe burns. Proper personal protective equipment should be used.

### Noise

Operating speed reducers may generate high noise levels. Use appropriate hearing protection and avoid extended exposure to high noise levels.

### Lubricants Hot and Under Pressure

The temperature of lubricants inside a speed reducer may be very high. The reducer should be allowed to cool to ambient temperature before removal of any vent, drain, level, or fill plugs, and before removing seals or bearing covers. Speed reducers without a pressure vent may also be under great internal pressure. Slowly loosen the lubricant fill plug above the lubricant level to vent any internal pressure before further disassembling.

### Lubricant Contact

Contact with lubricants can present safety concerns. Proper personal protective equipment should be used whenever handling speed reducer lubricants. Consult the lubricant MSDS sheet which is often available on the lubrication manufacturer's website.

### FDA, USDA, and NSF Applications

Factory supplied lubricants may not be suitable or safe for applications involving food, drugs and similar products. This includes applications subject to FDA, USDA, NSF or other regulatory jurisdiction. Consult the lubricant supplier or Winsmith for acceptable lubricants.

### Inspection and Lubrication

Ensure proper operation by regularly inspecting the speed reducer and following all maintenance, operation and lubrication guidelines.



**PEERLESS-WINSMITH, INC.**

SUBSIDIARY OF **HBD INDUSTRIES, INC.**

172 EATON STREET, SPRINGVILLE, NY 14141-1197  
PHONE: 716/592-9310 • FAX 716/592-9546  
WEBSITES: [www.WINSMITH.com](http://www.WINSMITH.com)

PWS-198918 Printed in U.S.A.